

DRN



Multi-channel open impeller

All product images are indicative only

General characteristics

Multi-channel open impeller	
motor power	1,1 ÷ 4,1 kW
poles	2 / 4 / 6
delivery port	DN65 ÷ DN150 horizontal
free passage	40 ÷ 100 mm
max flow rate	47.1 l/s
max head	23.2 m

Electromechanical assembly

Electromechanical assembly in GJL-250 cast iron, for submerged operation. Seal set comprising 2 (two) opposing silicon carbide mechanical seals in inspectable oil sump. Ecological dry motor. Series available in ATEX explosion-proof version.

Applications

Designed for mainly professional and industrial use such as wastewater treatment plants, sewage systems and livestock farms, it is particularly suitable for the treatment of liquids containing suspended solids or filaments, and low or medium density activated sludges. This series is prefitted for installation of the ZENIT cooling system for dry or semi-submerged installation.

Construction materials

Case	Cast iron EN-GJL 250
Impeller	Cast iron EN-GJL-250
Nuts and bolts	Stainless steel - Class A2-70
Standard gasket	Rubber - NBR
Shaft	Stainless steel - AISI 420
Cooling jacket	Carbon steel - Fe360 ÷ Fe370
Paint type	Ecological bicomponent epoxy (medium thickness 150 µm)
Set of standard mechanical seals	Two silicon carbide mechanical seals (2SiC)

Operating limits

Maximum operating temperature	40 °C
PH of treated fluid	6 ÷ 14
Viscosity of treated fluid	1 mm ² /s
Maximum immersion depth	20 m
Density of treated fluid	1 Kg/dm ³
Maximum acoustic pressure	70 dB
max starts per hour	30

DRN

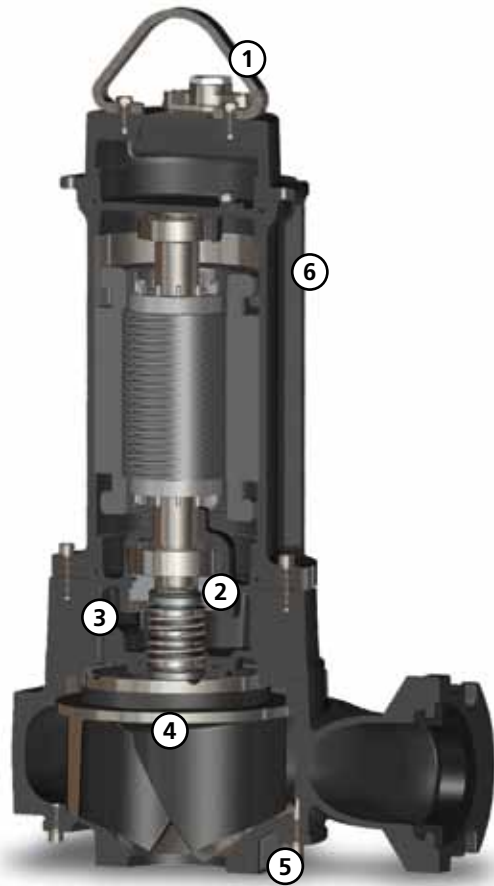

Cooling system

Dry installation available using the cooling jacket (see details to page 17)



Cable gland

Cable gland system to guarantee perfect water-tightness. The GAS thread ring-nut can be removed to fix a rigid or flexible duct to the cable gland to protect the power supply cable



Mechanical seals

Two silicon carbide (2SiC) mechanical seals in oil sump



Oil sump

Large oil sump to guarantee longer mechanical seal lifetime. A threaded flange can be easily removed to replace the mechanical seals



Drive shaft

A special bronze bush coupled to the tapered shaft enables quick and easy impeller clearance adjustment, thus maintaining the pump's hydraulic specifications



Anti-clogging system

The special design of the hydraulic part ensures the expulsion of suspended solids and prevents fouling of the impeller



EX

Models available on request with ATEX certification, suitable for installation in the presence of potentially explosive gases, powders and liquids

CE 0496 Ex II 2GD Ex db k c IIB T5 Ex tb IIIC T100°C IP68

DRN

Models with horizontal DN65 PN10-16 flanged delivery port - 2 poles

Performances

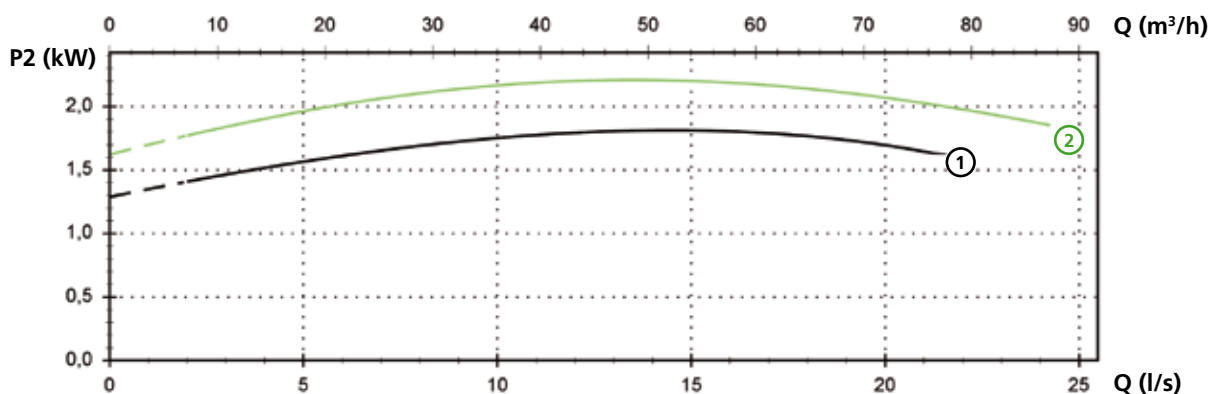
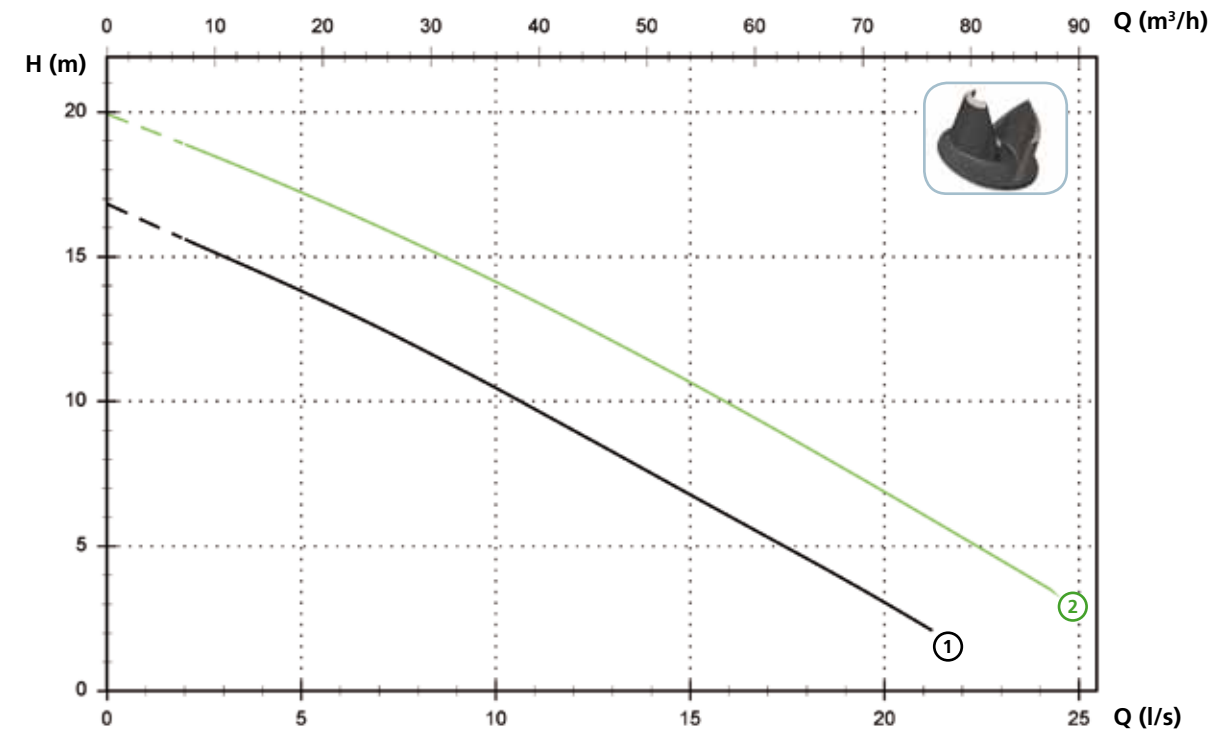

Technical data

	V	Phases	P1 (kW)	P2 (kW)	A	Rpm	Start	Ø	Cable (*)	Free passage
① DRN 250/2/65 A1DM/50	230	1	2.8	1.8	12.5	2900	Dir	DN65 PN10-16	A - B	40 mm
① DRN 250/2/65 A1DT/50	400	3	2.5	1.8	4.3	2900	Dir	DN65 PN10-16	A - B	40 mm
② DRN 300/2/65 A1DT/50	400	3	2.9	2.2	5.1	2900	Dir	DN65 PN10-16	A - B	40 mm

(*) A = 07RN-F 4G1.5+3x1 - 10 m (standard version). Electrical and mechanical features are equal to the cable H07RN-F
 B = NSSHOU-J 4G1.5+2x0.75 - 10 m (ATEX version)

Models with horizontal DN65 PN10-16 flanged delivery port - 2 poles

Performances

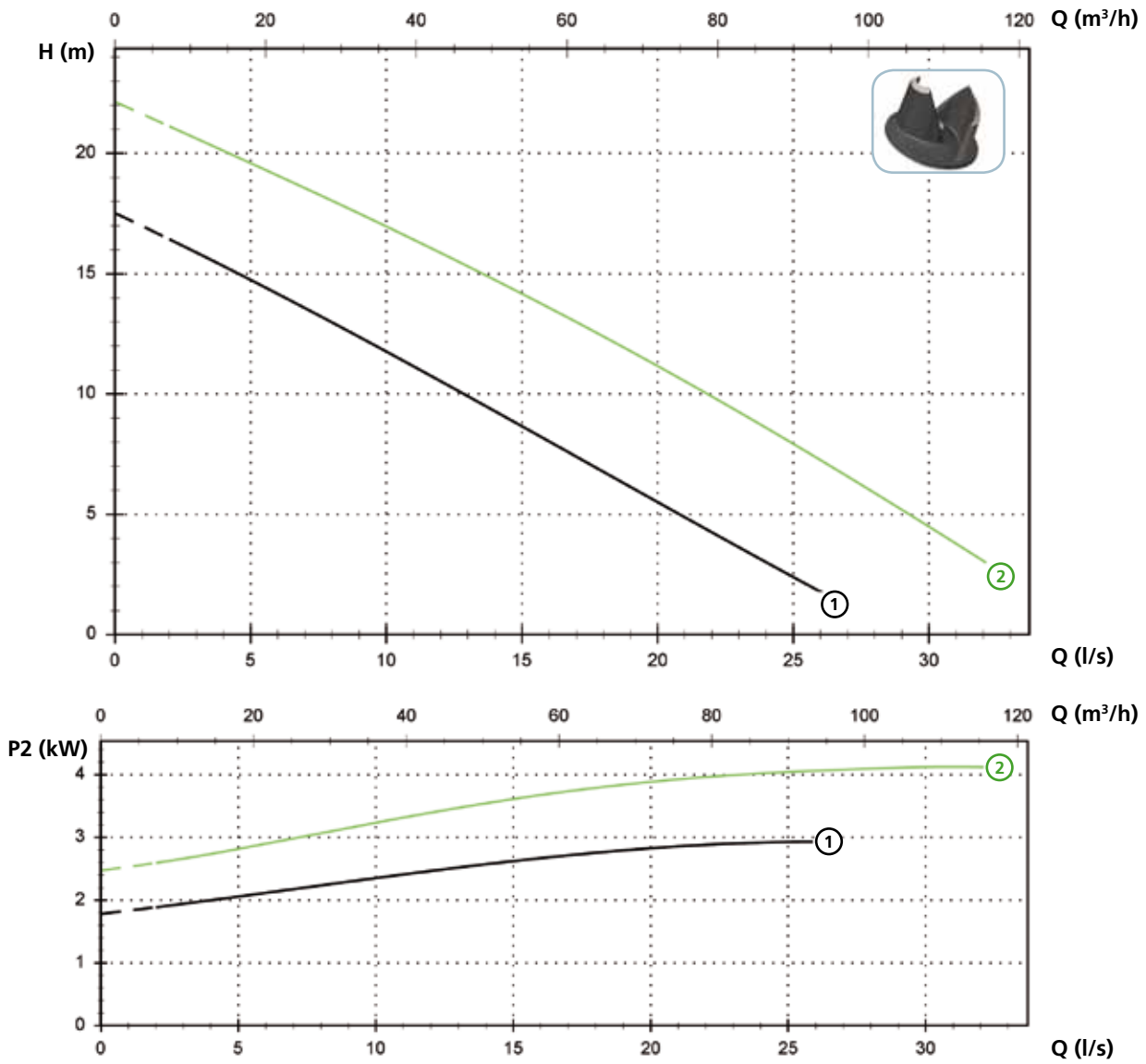

Technical data

	V	Phases	P1 (kW)	P2 (kW)	A	Rpm	Start	Ø	Cable (*)	Free passage	
①	DRN 400/2/65 A1FT/50	400	3	4.0	3	6.7	2900	Dir	DN65 PN10-16	A - B	50 mm
②	DRN 550/2/65 A1FT/50	400	3	5.0	4.1	8.7	2900	Dir	DN65 PN10-16	A - B	50 mm

(*) A = 07RN-F 4G1.5+3x1 - 10 m (standard version). Electrical and mechanical features are equal to the cable H07RN-F
 B = NSSHOU-J 4G2.5+2x0.75 - 10 m (ATEX version)

DRN

Models with horizontal DN80 PN10-16 flanged delivery port - 2 poles

Performances

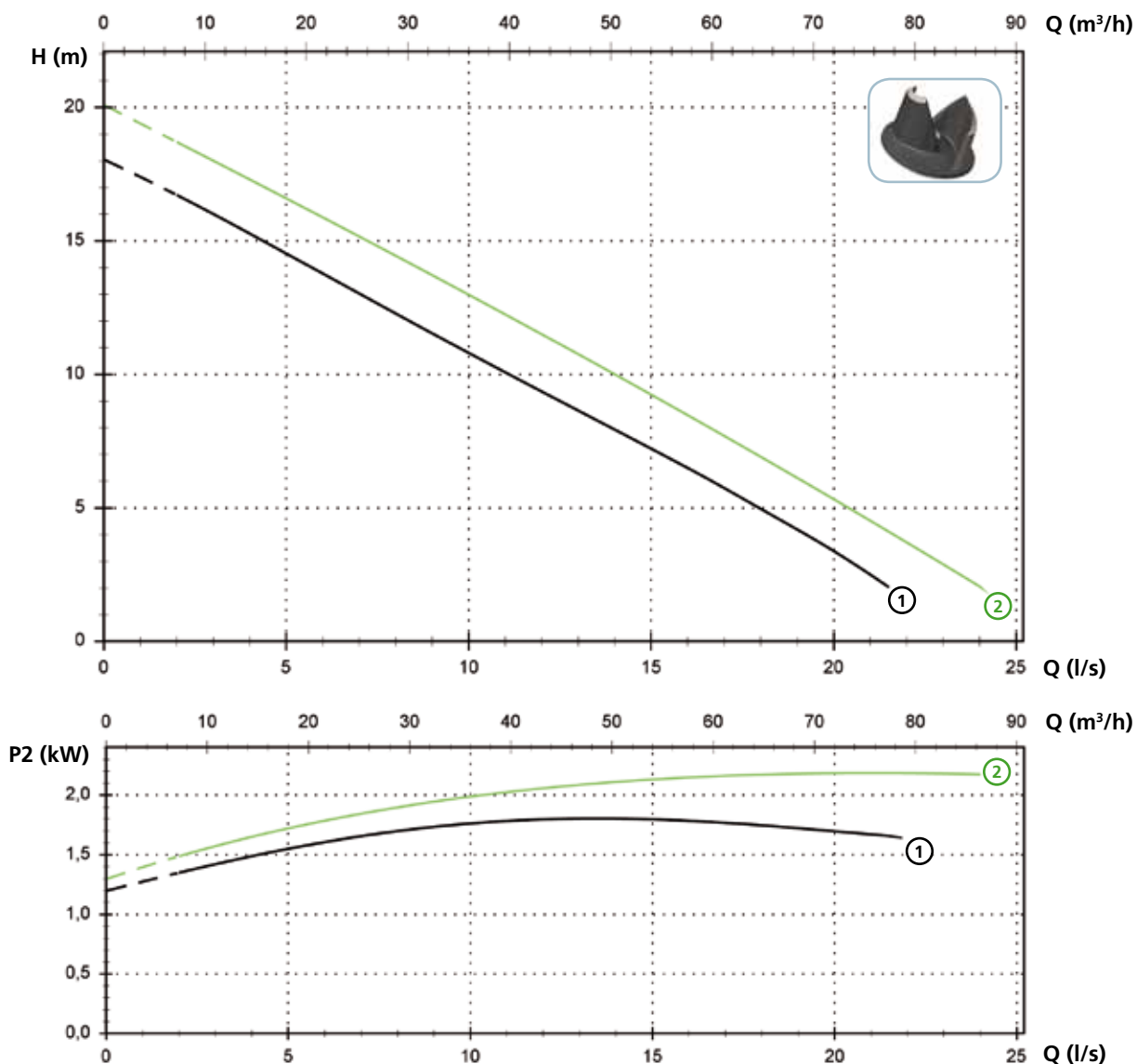

Technical data

	V	Phases	P1 (kW)	P2 (kW)	A	Rpm	Start	Ø	Cable (*)	Free passage
① DRN 250/2/80 A1DM/50	230	1	2.8	1.8	12.5	2900	Dir	DN80 PN10-16	A - B	40 mm
① DRN 250/2/80 A1DT/50	400	3	2.5	1.8	4.3	2900	Dir	DN80 PN10-16	A - B	40 mm
② DRN 300/2/80 A1DT/50	400	3	2.9	2.2	5.1	2900	Dir	DN80 PN10-16	A - B	40 mm

(*) A = 07RN-F 4G1.5+3x1 - 10 m (standard version). Electrical and mechanical features are equal to the cable H07RN-F
 B = NSSHOU-J 4G1.5+2x0.75 - 10 m (ATEX version)

Models with horizontal DN80 PN10-16 flanged delivery port - 2 poles

Performances

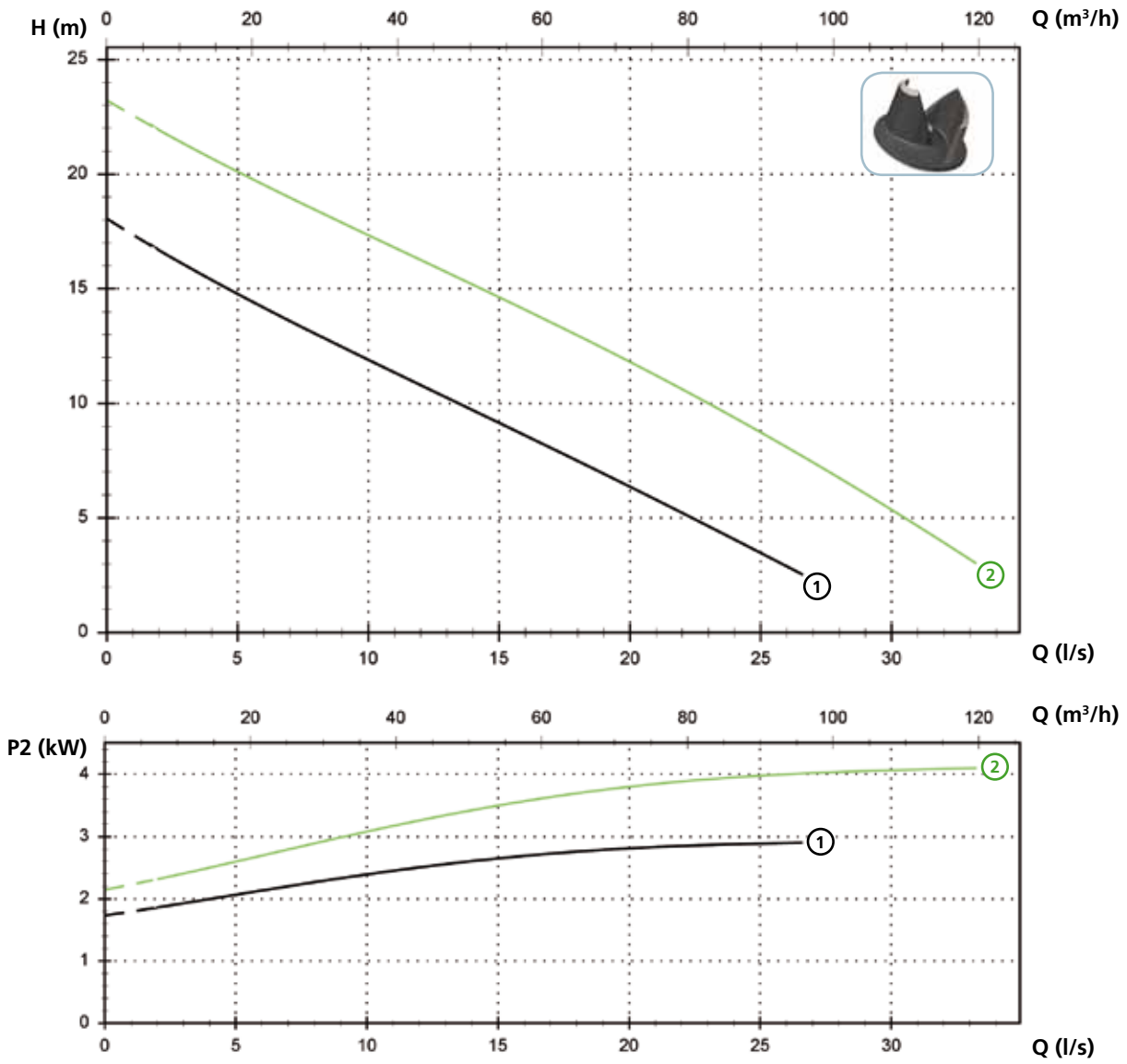

Technical data

	V	Phases	P1 (kw)	P2 (kw)	A	Rpm	Start	Ø	Cable (*)	Free passage
① DRN 400/2/80 A1FT/50	400	3	4.0	3	6.7	2900	Dir	DN80 PN10-16	A - B	45 mm
② DRN 550/2/80 A1FT/50	400	3	5.0	4.1	8.7	2900	Dir	DN80 PN10-16	A - B	45 mm

(*) A = 07RN-F 4G1.5+3x1 - 10 m (standard version). Electrical and mechanical features are equal to the cable H07RN-F
 B = NSSHOU-J 4G2.5+2x0.75 - 10 m (ATEX version)

DRN

Models with horizontal DN100 PN10-16 flanged delivery port - 2 poles

Performances

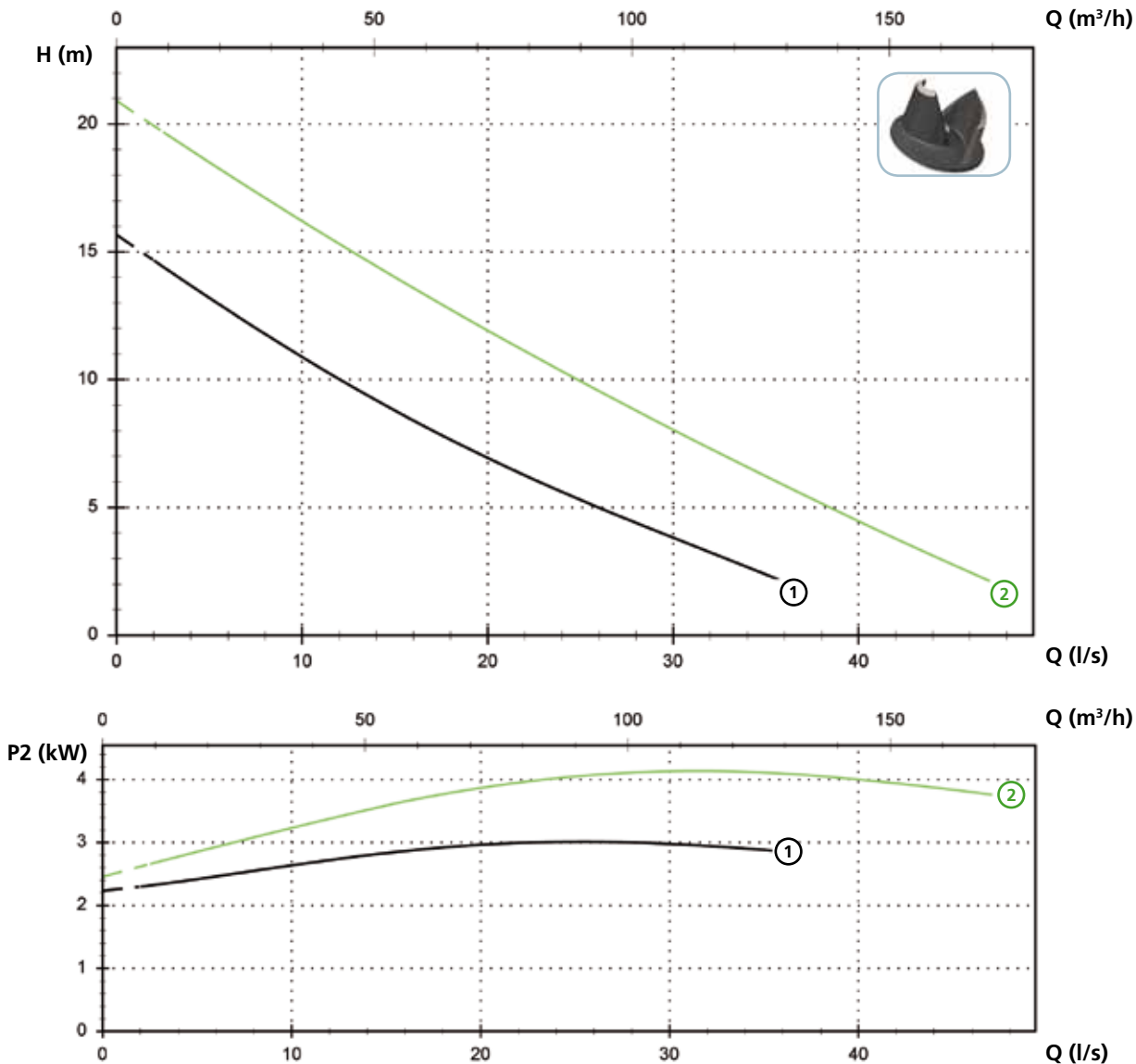

Technical data

	V	Phases	P1 (kW)	P2 (kW)	A	Rpm	Start	Ø	Cable (*)	Free passage
① DRN 400/2/100 A1FT/50	400	3	4.0	3	6.7	2900	Dir	DN100 PN10-16	A - B	50 mm
② DRN 550/2/100 A1FT/50	400	3	5.0	4.1	8.7	2900	Dir	DN100 PN10-16	A - B	50 mm

(*) A = 07RN-F 4G1.5+3x1 - 10 m (standard version). Electrical and mechanical features are equal to the cable H07RN-F
 B = NSSHOU-J 4G2.5+2x0.75 - 10 m (ATEX version)

Models with horizontal DN80 PN10-16 flanged delivery port - 4 poles

Performances

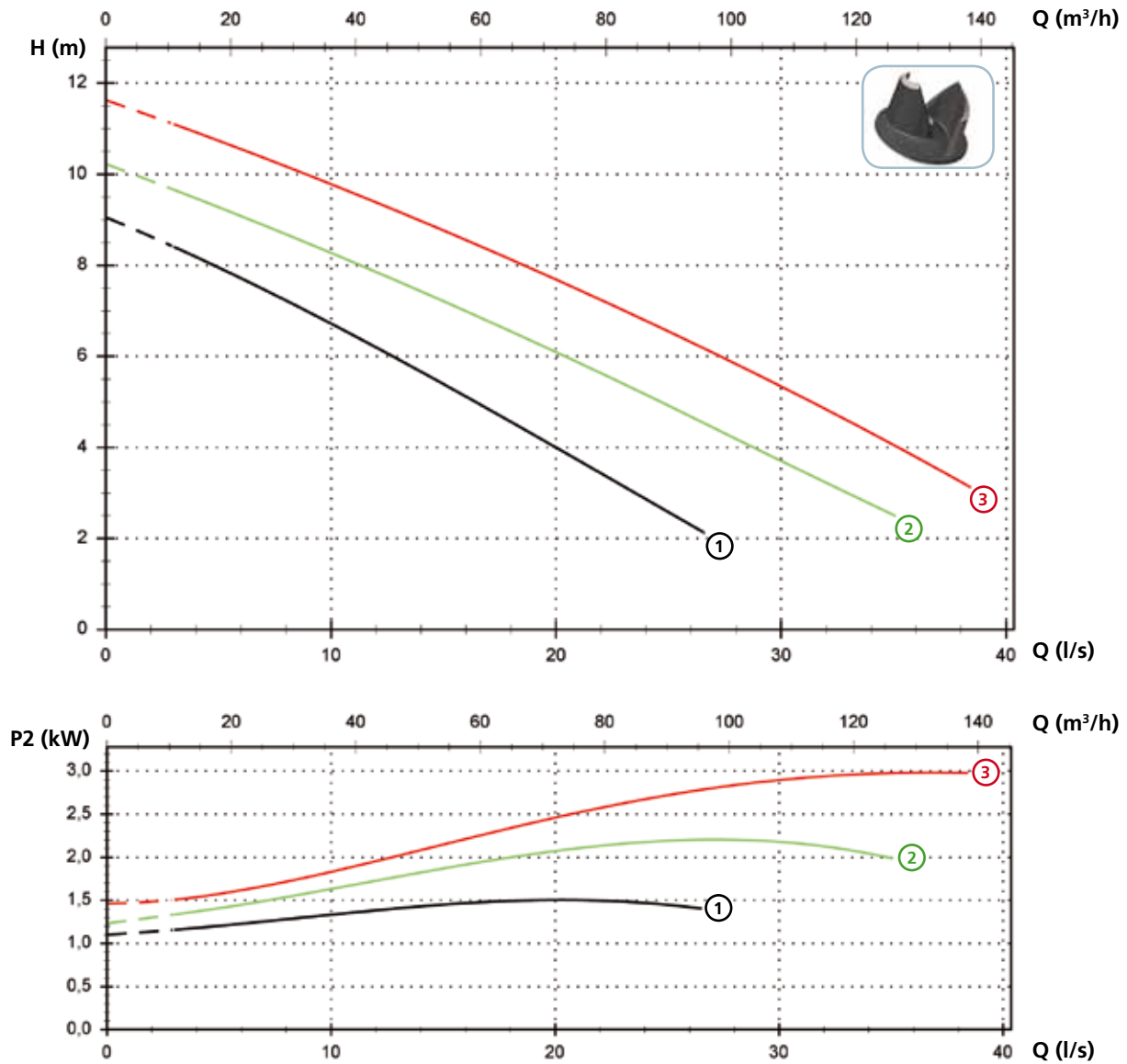

Technical data

	V	Phases	P1 (kW)	P2 (kW)	A	Rpm	Start	Ø	Cable (*)	Free passage
① DRN 200/4/80 A1DT/50	400	3	2.0	1.5	4.1	1450	Dir	DN80 PN10-16	A - B	80 mm
② DRN 300/4/80 A1FT/50	400	3	2.9	2.2	5.8	1450	Dir	DN80 PN10-16	A - C	80 mm
③ DRN 400/4/80 A1FT/50	400	3	3.7	3	7.3	1450	Dir	DN80 PN10-16	A - C	80 mm

(*) A = 07RN-F 4G1.5+3x1 - 10 m (standard version). Electrical and mechanical features are equal to the cable H07RN-F
 B = NSSHOU-J 4G1.5+2x0.75 - 10 m (ATEX version)
 C = NSSHOU-J 4G2.5+2x0.75 - 10 m (ATEX version)

DRN

Models with horizontal DN100 PN10-16 flanged delivery port - 4 poles

Performances

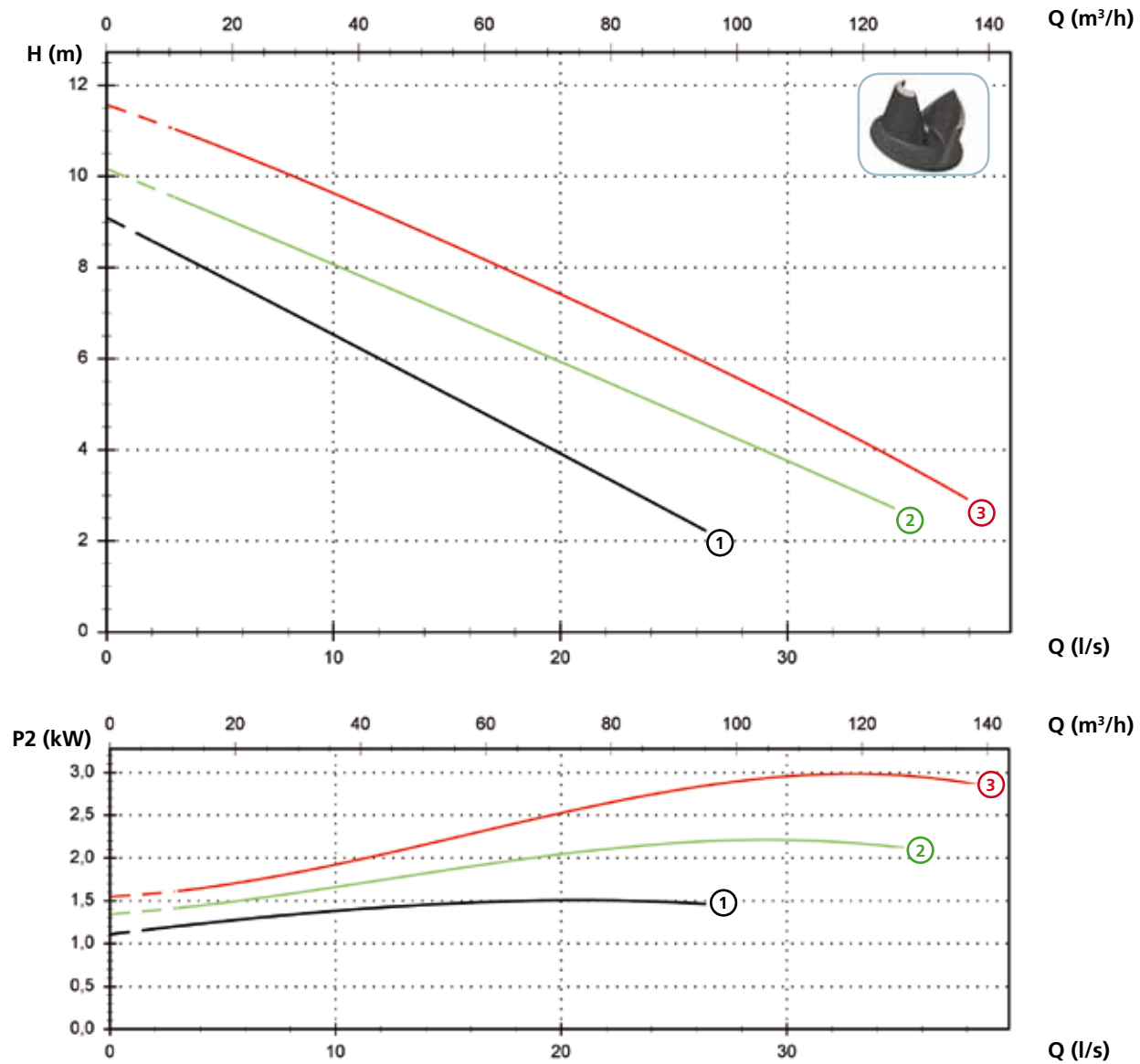

Technical data

	V	Phases	P1 (kW)	P2 (kW)	A	Rpm	Start	Ø	Cable (*)	Free passage
① DRN 200/4/100 A1DT/50	400	3	2.0	1.5	4.1	1450	Dir	DN100 PN10-16	A - B	80 mm
② DRN 300/4/100 A1FT/50	400	3	2.9	2.2	5.8	1450	Dir	DN100 PN10-16	A - C	80 mm
③ DRN 400/4/100 A1FT/50	400	3	3.7	3	7.3	1450	Dir	DN100 PN10-16	A - C	80 mm

(*) A = 07RN-F 4G1.5+3x1 - 10 m (standard version). Electrical and mechanical features are equal to the cable H07RN-F
 B = NSSHOU-J 4G1.5+2x0.75 - 10 m (ATEX version)
 C = NSSHOU-J 4G2.5+2x0.75 - 10 m (ATEX version)

Models with horizontal DN80 PN10-16 flanged delivery port - 6 poles

Performances

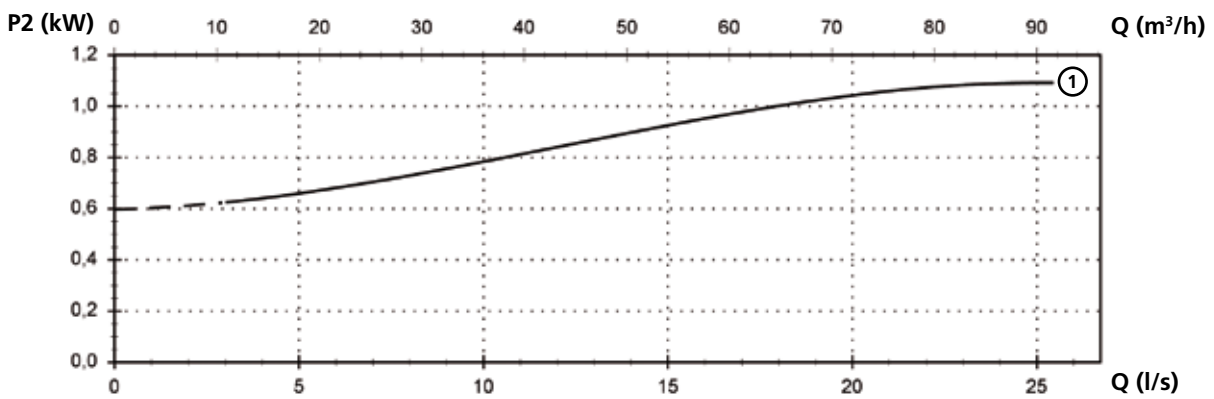
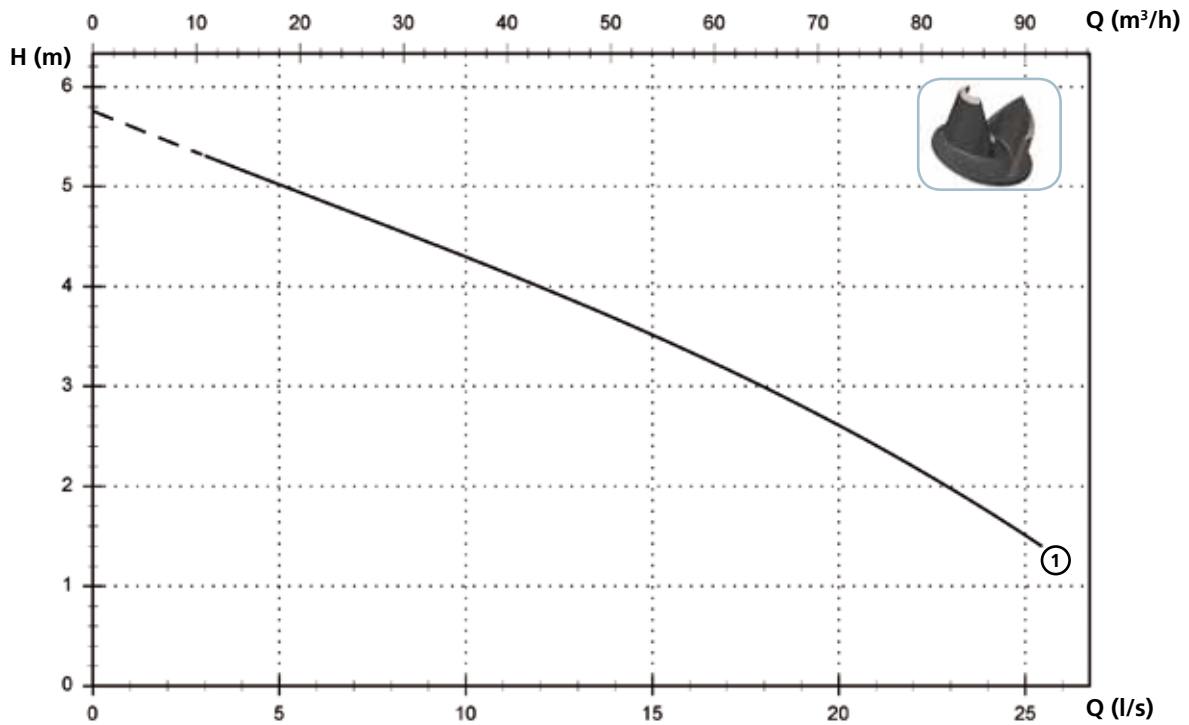

Technical data

	V	Phases	P1 (kW)	P2 (kW)	A	Rpm	Start	Ø	Cable (*)	Free passage
① DRN 150/6/80 A1DT/50	400	3	1.6	1.1	3.7	960	Dir	DN80 PN10-16	A - B	80 mm

(*) A = 07RN-F 4G1.5+3x1 - 10 m (standard version). Electrical and mechanical features are equal to the cable H07RN-F
 B = NSSHO-J 4G1.5+2x0.75 - 10 m (ATEX version)

DRN

Models with horizontal DN100 PN10-16 flanged delivery port - 6 poles

Performances

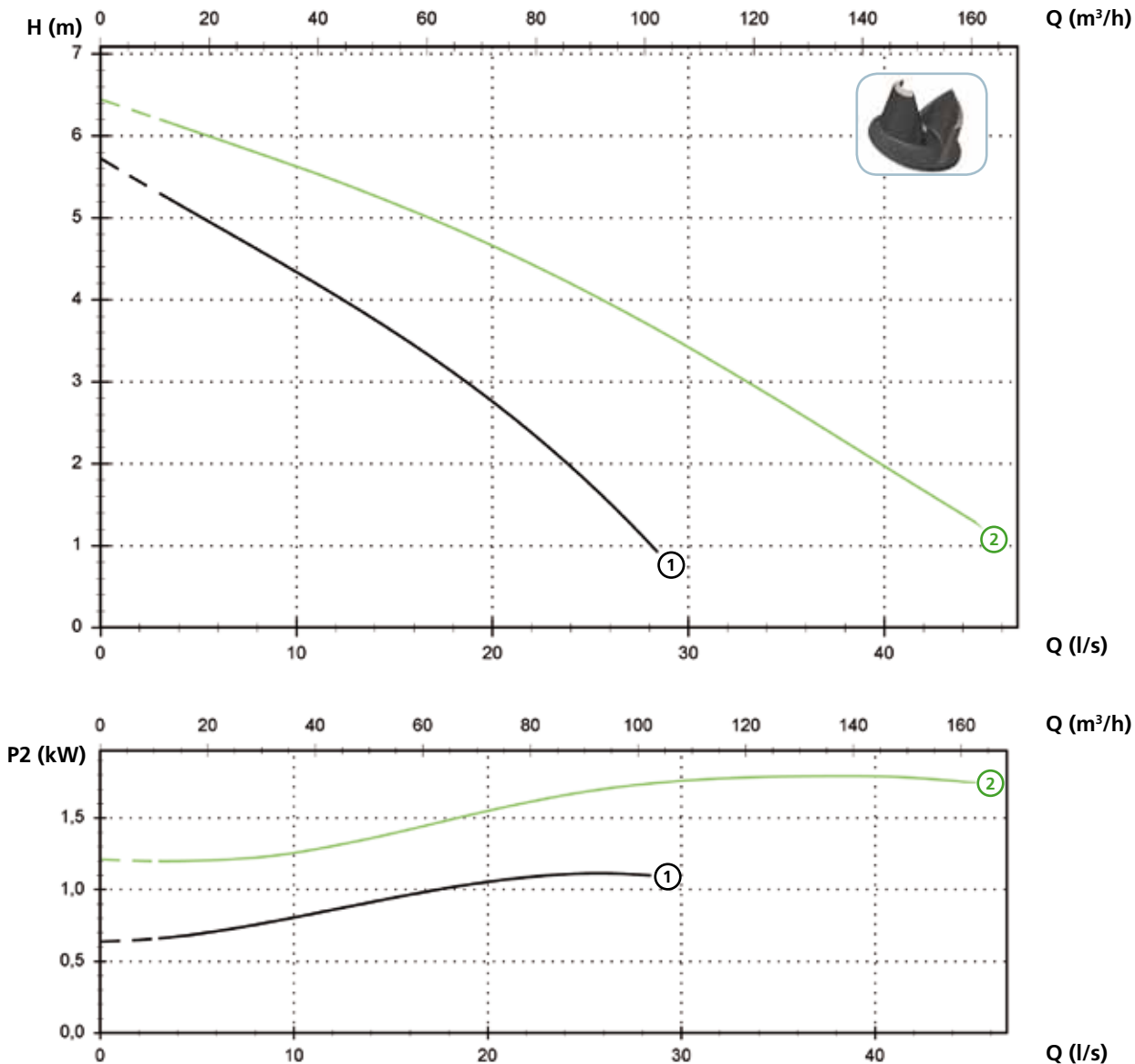

Technical data

	V	Phases	P1 (kW)	P2 (kW)	A	Rpm	Start	Ø	Cable (*)	Free passage	
①	DRN 150/6/100 A1DT/50	400	3	1.6	1.1	3.7	960	Dir	DN100 PN10-16	A - B	80 mm
②	DRN 250/6/100 A1FT/50	400	3	2.6	1.8	5.7	960	Dir	DN100 PN10-16	A - C	100 mm

(*) A = 07RN-F 4G1.5+3x1 - 10 m (standard version). Electrical and mechanical features are equal to the cable H07RN-F
 B = NSSHOU-J 4G1.5+2x0.75 - 10 m (ATEX version)
 C = NSSHOU-J 4G2.5+2x0.75 - 10 m (ATEX version)

Models with horizontal DN150 PN10-16 flanged delivery port - 6 poles

Performances

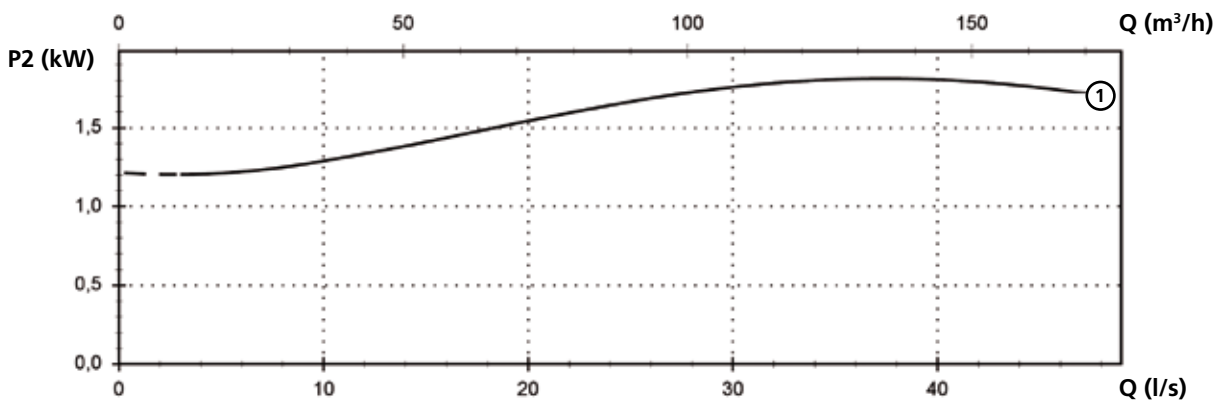
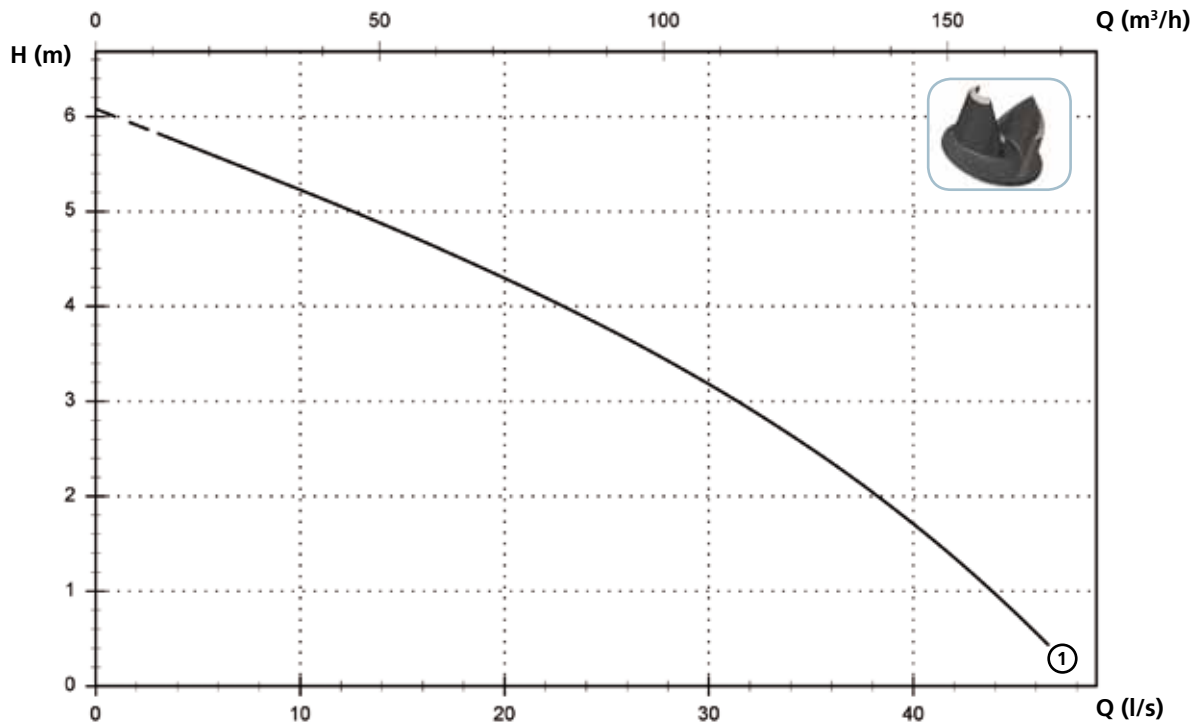

Technical data

	V	Phases	P1 (kW)	P2 (kW)	A	Rpm	Start	Ø	Cable (*)	Free passage
① DRN 250/6/150 A1FT/50	400	3	2.6	1.8	5.7	960	Dir	DN150 PN10-16	A - B	100 mm

(*) A = 07RN-F 4G1.5+3x1 - 10 m (standard version). Electrical and mechanical features are equal to the cable H07RN-F
 B = NSSHO-J 4G2.5+2x0.75 - 10 m (ATEX version)

DRN

Versions available

(Key to versions on page 16)

	Electrical variants											Cooling				Mechanical seals				
	N A E	T	T C	T C D	T C D T	T C D G T	T C G	T C S T	T C S G T	T S	T R	T R G	N	CC CCE	FT	C G F T	2SIC	SICM	SICAL	2SICAL
DRN 250/2/65 A1DM/50				●									●	●			●			
DRN 250/2/65 A1DT/50		●							●				●	●			●			
DRN 300/2/65 A1DT/50		●							●				●	●			●			
DRN 400/2/65 A1FT/50		●							●				●	●			●			
DRN 550/2/65 A1FT/50		●							●				●	●			●			
DRN 250/2/80 A1DM/50				●									●	●			●			
DRN 250/2/80 A1DT/50		●							●				●	●			●			
DRN 300/2/80 A1DT/50		●							●				●	●			●			
DRN 400/2/80 A1FT/50		●							●				●	●			●			
DRN 550/2/80 A1FT/50		●							●				●	●			●			
DRN 400/2/100 A1FT/50		●							●				●	●			●			
DRN 550/2/100 A1FT/50		●							●				●	●			●			
DRN 200/4/80 A1DT/50		●							●				●	●			●			
DRN 300/4/80 A1FT/50		●							●				●	●			●			
DRN 400/4/80 A1FT/50		●							●				●	●			●			
DRN 200/4/100 A1DT/50		●							●				●	●			●			
DRN 300/4/100 A1FT/50		●							●				●	●			●			
DRN 400/4/100 A1FT/50		●							●				●	●			●			
DRN 150/6/80 A1DT/50		●							●				●	●			●			
DRN 150/6/100 A1DT/50		●							●				●	●			●			
DRN 250/6/100 A1FT/50		●							●				●	●			●			
DRN 250/6/150 A1FT/50		●							●				●	●			●			

NOTE FOR SINGLE PHASE PUMPS: thermal protections into the winding have to be connected to the electrical panel.
 Start capacitor inside the pump. Circuit breaker supplied but not connected to the pump cable.
 The use of an electrical panel as circuit breaker housing is mandatory. For installation please see use and maintenance booklet.

Packaging dimension

	A	B	C		A	B	C
DRN 250/2/65 A1DM(T)/50	725	445	415	DRN 200/4/100 A1DT/50	725	445	415
DRN 300/2/65 A1DT/50	725	445	415	DRN 300/4/100 A1FT/50	725	445	415
DRN 400/2/65 A1FT/50	725	445	415	DRN 400/4/100 A1FT/50	725	445	415
DRN 550/2/65 A1FT/50	725	445	415	DRN 150/6/80 A1DT/50	915	515	555
DRN 250/2/80 A1DM(T)/50	725	445	415	DRN 150/6/100 A1DT/50	915	515	555
DRN 300/2/80 A1DT/50	725	445	415	DRN 250/6/100 A1FT/50	915	515	555
DRN 400/2/80 A1FT/50	725	445	415	DRN 250/6/150 A1FT/50	915	515	555
DRN 550/2/80 A1FT/50	725	445	415				
DRN 400/2/100 A1FT/50	725	445	415				
DRN 550/2/100 A1FT/50	725	445	415				
DRN 200/4/80 A1DT/50	725	445	415				
DRN 300/4/80 A1FT/50	725	445	415				
DRN 400/4/80 A1FT/50	725	445	415				

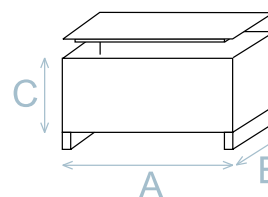

Dimension in mm

All weights and dimensions are indicative only

Overall dimensions and weights

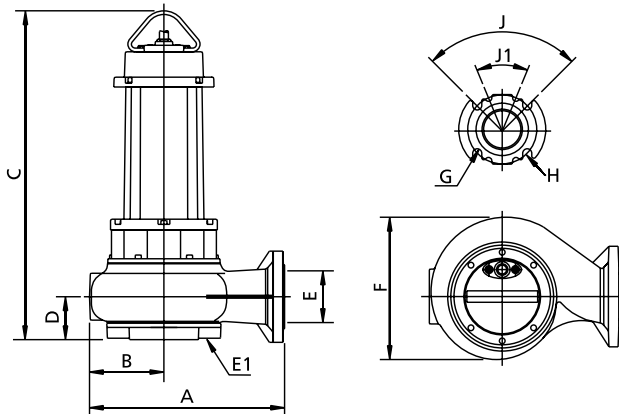

	A	B	C	D	E	E1(*)	F	G	H	J	J1	kg
DRN 250/2/65 A1DM(T)/50	340	135	545	80	65	65	255	18	145	90°	-	56
DRN 300/2/65 A1DT/50	340	135	545	80	65	65	255	18	145	90°	-	58
DRN 400/2/65 A1FT/50	340	135	685	80	65	65	260	18	145	90°	-	74
DRN 550/2/65 A1FT/50	340	135	685	80	65	65	260	18	145	90°	-	77
DRN 250/2/80 A1DM(T)/50	345	135	545	80	80	65	255	18	160	90°	45°	56
DRN 300/2/80 A1DT/50	345	135	545	80	80	65	255	18	160	90°	45°	58
DRN 400/2/80 A1FT/50	345	135	685	80	80	65	260	18	160	90°	45°	79
DRN 550/2/80 A1FT/50	345	135	685	80	80	65	260	18	160	90°	45°	77
DRN 400/2/100 A1FT/50	430	170	705	90	100	80	325	18	180	45°	-	82
DRN 550/2/100 A1FT/50	430	170	705	90	100	80	325	18	180	45°	-	85
DRN 200/4/80 A1DT/50	390	150	590	90	80	100	290	18	160	90°	45°	66
DRN 300/4/80 A1FT/50	390	150	700	90	80	100	290	18	160	90°	45°	87
DRN 400/4/80 A1FT/50	390	150	700	90	80	100	290	18	160	90°	45°	89
DRN 200/4/100 A1DT/50	415	160	595	90	100	100	310	18	180	45°	-	68
DRN 300/4/100 A1FT/50	415	160	700	90	100	100	310	18	180	45°	-	89
DRN 400/4/100 A1FT/50	415	160	700	90	100	100	310	18	180	45°	-	91
DRN 150/6/80 A1DT/50	390	150	590	90	80	100	290	18	160	90°	45°	66
DRN 150/6/100 A1DT/50	415	160	595	90	100	100	310	18	180	45°	-	68
DRN 250/6/100 A1FT/50	505	200	740	115	100	100	395	18	180	45°	-	109
DRN 250/6/150 A1FT/50	505	200	740	115	150	100	395	24	240	45°	-	112

Dimensions in mm

All weights and dimensions are indicative only

(*) DN of the suction flange - PN6

Installations available

