

ShinMaywa

Land-Type Blower

(Roots-Type) **ARS Series**

Patent pending

New!

The Right Choice for Energy Efficiency
and Low Maintenance



ARS50



ARS125



ARS250

ARS Series

Introducing ShinMaywa's New Energy-Efficient, Low-Maintenance Blowers Inspired by the Innovative Cooling Silencer

ARS Series

ARS Series

50~250 mm outlet diameter
1.5~132 kW output

The ARS Series of high-efficiency blowers feature innovations such as the Cooling Silencer (patent pending) and spur-type rotors. The result is enhanced energy efficiency, low maintenance and improved durability across a wide range of applications.

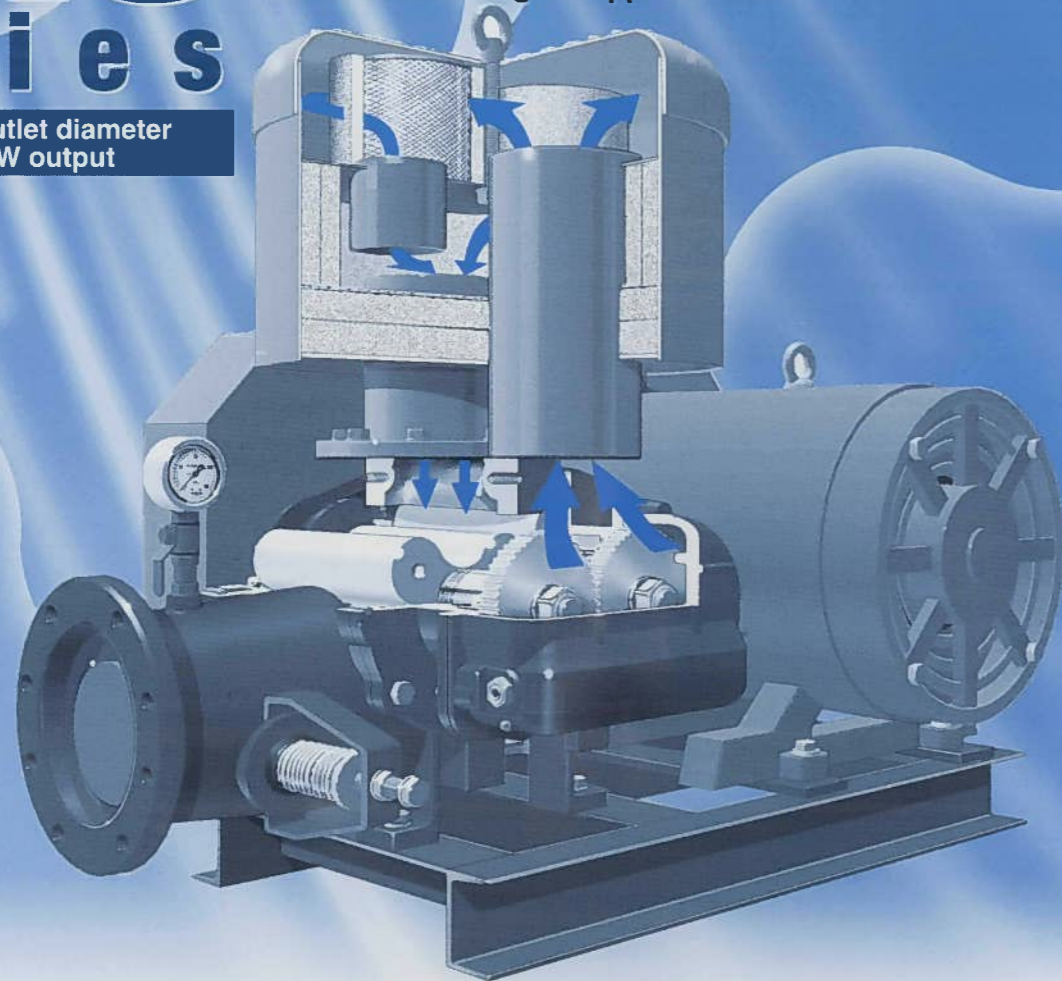

Now featuring a Pulse Eraser (pressure pulsation reduction mechanism) to reduce noise and pressure pulsation.

Spur-type rotors, which discharge air rhythmically, tend to generate more noise and pressure pulsations than do helical rotors. Our new ARS Series features specially designed nozzle-shaped grooves of varying lengths on the inner wall of the casing. They absorb the abrupt backflow of compressed air, resulting in less noise and reduced pressure pulsations (patent pending).

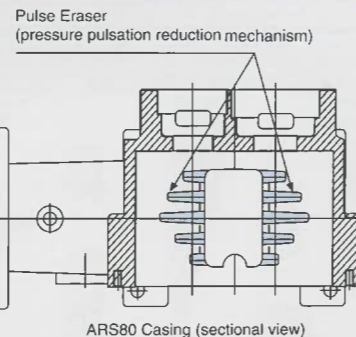

Model ARS80 is available with an optional rubber vibration isolator that absorbs 97% of mechanical vibrations and prevents their propagation.

The Benefits of the Cooling Silencer (patent pending)

The ARS Series incorporates our innovative Cooling Silencer. Air is drawn in over the gear-side bearing to significantly cool the bearing, resulting in improved durability and higher-speed operation. This feature is effectively integrated into a compact, low-profile body.

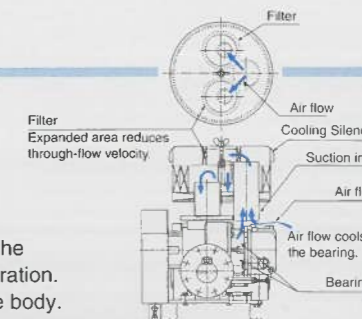

With a significant bearing-cooling effect

Higher-speed operation

Greatly improved isentropic efficiency

Advanced spur-type rotors—a recent innovation—contribute to high-speed operation for greatly improved isentropic efficiency.

Estimated annual energy savings:

	Conventional model	New model
Air flow rate (m ³ /min)	5.74	
Discharge pressure (kPa)	50	
Power requirement (kW)	8.5	7.1
Isentropic efficiency (%)	48.5	58.1
Motor output (kW)	11	7.5
Energy cost (¥)	1,266,000	1,057,000

(Operating period: 24 hrs/day (8,760 hrs/year) ¥17/kWh)
The energy savings are estimated as follows:
Difference in electricity cost:
1,266,000—1,057,000 = ¥209,000/year

What's more, You can reduce your annual power consumption even more by selecting the next size smaller motor for your application.

Extended air flow range

The bearing-cooling effect allows for high-speed operation, resulting in an extended air flow range. This allows you to use the next-size-smaller diameter for your application.

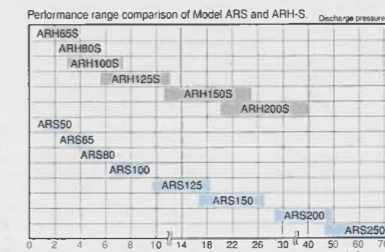

You can reduce your annual power consumption even more by selecting the next size smaller diameter for your application.

Standard models develop pressure up to 80 kPa. An Industry First

It's an industry first. The bearing cooling effect requires no forced cooling, making it possible to achieve pressures as high as 80 kPa. Our new standard models exceed 60 kPa, a pressure at which conventional models require a water-cooled system or air cooling fan. (Discharge pressures exceeding 70 kPa require a totally enclosed fan-cooled motor.)

This blower requires no cooling water or air cooling fan.

Extended maintenance interval

The combination of an enhanced-efficiency blower with the bearing-cooling function of the suction silencer significantly lowers the bearing temperature. The result is improved bearing reliability for greatly extended grease and oil maintenance intervals. (The grease and oil maintenance interval is three months when the discharge pressure exceeds 60 kPa.)

Double the grease and oil maintenance interval to six months.

Compact rotors

The high-speed capability allows for smaller rotors. Compact rotors reduce the load on the bearings, resulting in equal or better reliability.

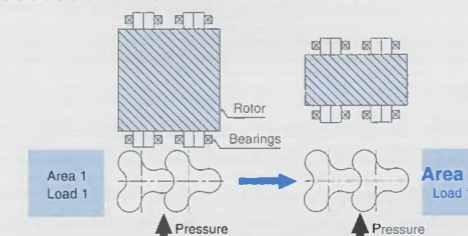

Count on improved durability through extended bearing life.

Lower maintenance and reduced energy costs

Greater Selection & Enhanced Space Efficiency

Our new models cover a wide range of needs. They offer highly compact designs, outlet diameters ranging from 50 to 250 mm, and outputs from 1.5 to 132 kW. (Model ARS50/65 is equivalent to our previous Model ARH50S. Model ARS80/100 is equivalent to our previous Model ARH65S-80S.)



Specifications

Discharge pressure:kPa [kg/cm²] Q: Air flow rate (m³/min) P: Power requirements(kW)

Table with columns for Outlet dia. mm, Model, Pulley No., Rotor speed (min⁻¹), and various discharge pressure and air flow rate values (10kPa to 80kPa) for models ARS50 through ARS250. The table lists specific Q and P values for each pressure and model combination.

Performance Curve

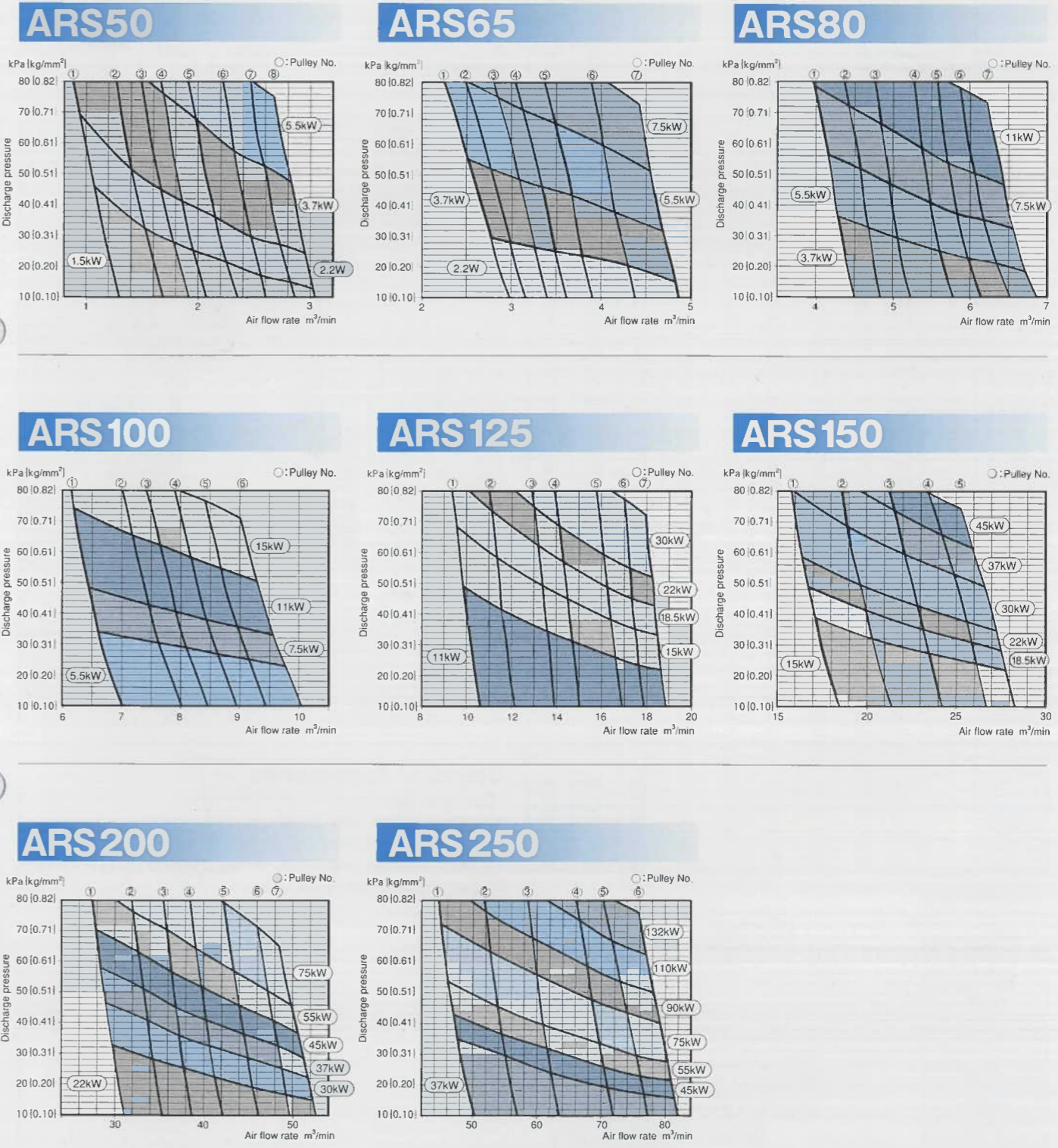

Notes:
-The air flow rate assumes standard suction conditions (20°C, 101.3 kPa absolute pressure, 65% relative humidity).
-Air flow rate tolerance: ±5%
-Consult us for any requirements not included in the table.
-For indoor use only. Consult us regarding outdoor applications.

Notes: -The air flow rate (measured according to JIS B8341) assumes standard suction conditions (20°C, 101.3 kPa absolute pressure, 65% relative humidity). Air flow rate tolerance: ±5%. Consult us for any requirements not included in the table. For indoor use only. Consult us regarding outdoor applications.

Selecting an Inverter-Controlled Model

All models are available with inverter control. This feature allows precise control of the air flow rate to accommodate water treatment volumes that vary seasonally and over time.

Operation at excessively slow speeds with the inverter would allow high-temperature compressed air to leak into the suction side through clearances between rotors (1) and between the rotors and casing wall (2), as illustrated below. This can result in a temperature rise that exceeds the bearing temperature limit, resulting in a blower failure.

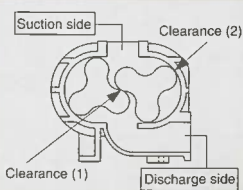
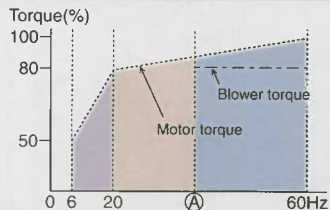

Notes: (A) indicates the lower limit of the frequency control range based on the blower temperature rise.

- 1) Blower torque remains constant when the motor speed is reduced because of the blower's constant-torque design.
- 2) When selecting an inverter, ensure the rated output of the inverter is equal to or greater than the rated output of the motor.
- 3) The control range of the inverter starts at 60 Hz regardless of the frequency of the power source. The control range depends on several factors including the application, motor output, and model.

Combination 1 General-purpose motor and inverter (V/F control)

Blower application (a) (Fig. 1)

The blower is usable within the frequency range from (A) to 60 Hz because the blower torque is less than the motor torque. The blower is not usable if the frequency falls below (A) because the blower temperature will rise.

Blower application (b) (Fig. 2)

The blower torque exceeds the motor torque when the frequency is below (B). The blower is usable within the frequency range from (B) to 60 Hz.

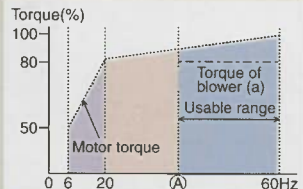

Figure 1 Blower (a) Frequency (Hz)

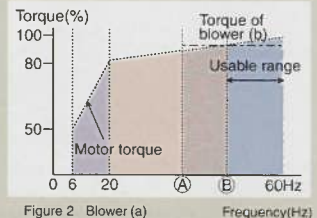

Figure 2 Blower (b) Frequency (Hz)

Combination 2 General-purpose motor and inverter (Vector control)

Both blowers (a) and (b) are usable within the range from (A) to 60 Hz. The blowers are not usable below (A) because the blower temperature will rise.

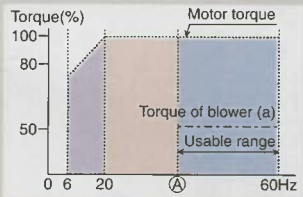

Figure 3 Blower (a) Frequency (Hz)

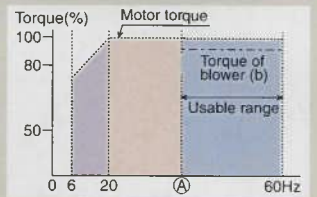

Figure 4 Blower (b) Frequency (Hz)

Combination 3 Inverter and constant-torque motor exclusively for use with inverter

Both blowers (a) and (b) are usable within the range from (A) to 60 Hz. The blowers are not usable below (A) because the blower temperature will rise.

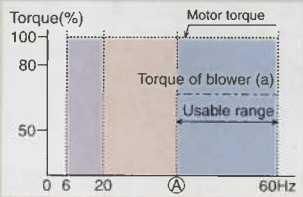

Figure 5 Blower (a) Frequency (Hz)

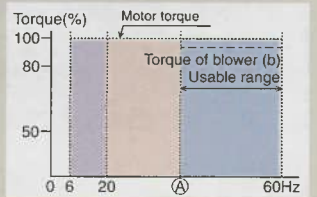

Figure 6 Blower (b) Frequency (Hz)

Consult us if you require inverter control. We can provide an inverter calculation sheet.



Safety Notice Before using this product, read the Instruction Manual thoroughly to ensure correct handling and operation.

Specifications and dimensions are subject to change without notice.

ShinMaywa Industries, Ltd.

Overseas Operations Department 2-43, Shiite 3-chome, Tsurumi-ku, Yokohama-shi, 230-0003, Japan
Telephone : +81-45-584-1321 Facsimile : +81-45-584-1320
e-mail : overseas@sb.shinmaywa.co.jp

ShinMaywa (America), Ltd.

10737 Gateway West, Suite 112
El Paso, Texas 79935, U.S.A.
Telephone : +1-915-594-9862
Facsimile : +1-915-594-9866
e-mail : salelpasso@aol.com

ShinMaywa (Asia) Pte. Ltd.

51 Goldhill Plaza #14-01
Singapore 308900
Telephone : +65-6224-0728
Facsimile : +65-6224-9678
e-mail : Asia.ad@shinmaywa.com.sg

ShinMaywa (Malaysia) Sdn. Bhd.

Suite 7.3, 7th Floor Menara Aik Hua, Changkat
Raja Chulan, 50200 Kuala Lumpur, Malaysia
Telephone : +60-3-2026-2388
Facsimile : +60-3-2026-2399
e-mail : smmsb@tm.net.my



ShinMaywa ONO PLANT

ISO 9001(No.956445)/ISO 14001(No.771888)

'06.6. Z-E151

Printed on recycled paper.

Printed in Japan 2.1®